

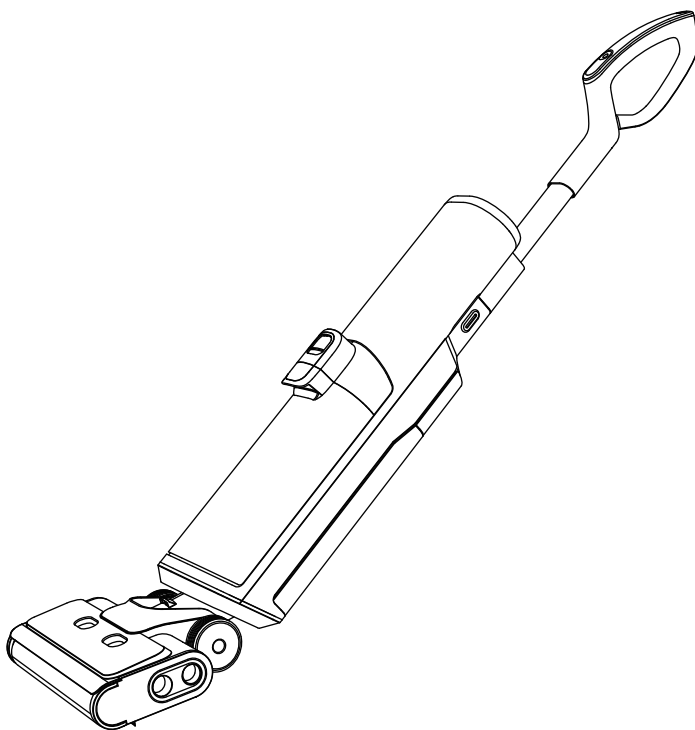

Wash Vac F20 Cordless Wet Dry Vacuum Cleaner

User's manual

Smart cleaning, simple life.



Live Smart,
Live Easy.

Proscenic Technology Co., Ltd.
Service support
Web:www.proscenic.com
E-mail:support@proscenic.com

Contents

Precautions	01
About Your Product	02
Product Use	04
Product Maintenance	07
Troubleshooting	10
Product Specification	11

Precautions

Please read the following precautions carefully before using this appliance:

- Use only indoors on non-carpeted floor surfaces such as vinyl, tile, sealed wood, etc. Be careful not to run over loose objects or carpet edges.
- Use only the battery pack and charger specified by the Proscenic. Using any other battery pack may cause personal injury and fire risk.
- Do not use your product to clean flammable or chemical products such as gasoline, strong acids, or strong alkalis; do not use WashVac F20 to pick up sharp objects such as metal nails, glass fragments, and needles.
- Do not touch the charger and plug with wet hands.
- Do not use WashVac F20 without the filter.
- Do not use the damaged power cable or plug. If WashVac F20 is dropped, damaged, left outdoors, falls into water, or fails to work properly, contact our service center.
- Be extra careful when cleaning on the stairs.
- Keep your hair, clothing, fingers, and all parts of your body away from openings and moving parts.
- Do not use WashVac F20 when the water depth exceeds 5 mm.
- Turn off this appliance before making any adjustments, replacing accessories, or storing this appliance.
- WashVac F20 can only be used, charged, and stored in a dry room where the temperature is higher than 4°C but lower than 80°C.
- If you accidentally drop the battery, liquid may run out of the battery. Avoid touching it. If touched accidentally, rinse with water. If liquid gets into your eyes, seek medical help.
- If this appliance overheats, makes abnormal noise, produces abnormal smell or leaks, stop using it immediately.
- For long-term storage, please turn off WashVac F20 and disconnect the power from the socket.
- Be sure to clean the dirty water tank after each use to avoid clogging, which will result in poor suction, motor overheating or shortened service life of this appliance.
- All data and technical descriptions in this manual are based on test results from Proscenic laboratory tests and Proscenic reserves the right of final interpretation.

About Your Product

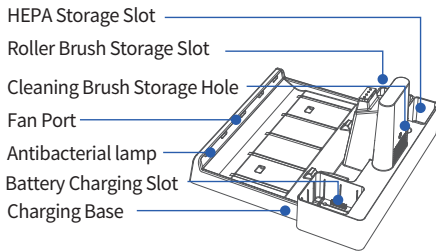
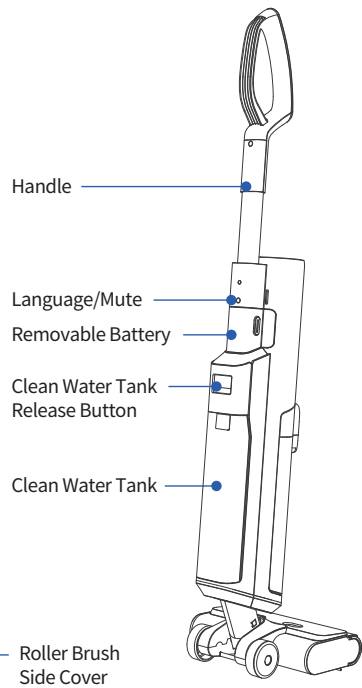
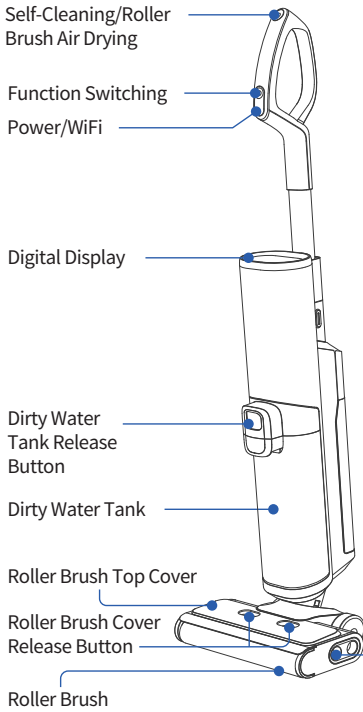

Cleaning Brush



Cleaning Solution



Roller Brush



APP Download and Connection Guide



User's Manual



Adapter



Battery

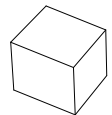

HEPA Filter

About Your Product

Display Indicator Diagram

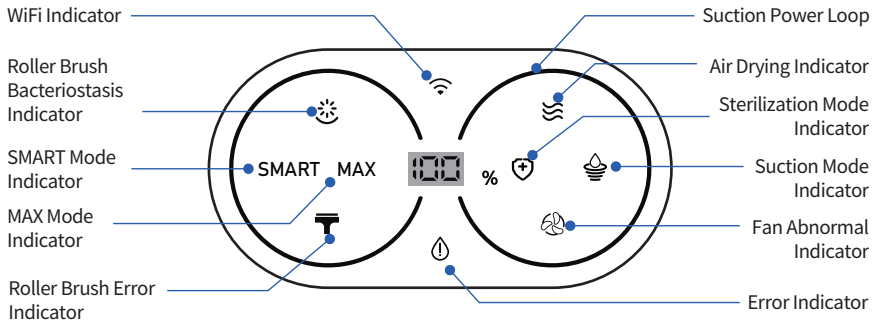

Accessories

Cleaning Tool:

Can be used to clean dirty water tank and tube.

Cleaning Solution:

It can remove dirt, grease and tough stains from hard floor surfaces such as tile, marble, sealed hardwood floors, etc. Add a bottle cap of cleaning solution (10ml) to each water tank filled with clean water, in a ratio of 1:100.

HEPA Filter:

The filtered dirty water and dust are discharged into the air to reduce air pollution and avoid water entering the motor and damaging it.

Roller Brush:

The roller head with bristles can be used for vacuuming and washing at the same time.



Cleaning Tool



Cleaning Solution

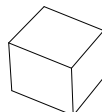

HEPA Filter



Roller Brush

Assembly

1. To assemble the handle, insert it directly into the appliance until you hear a click.
2. To disassemble the handle, use a tool (such as a screwdriver) to release the handle by pressing the spring, and then lift the released handle from the appliance.

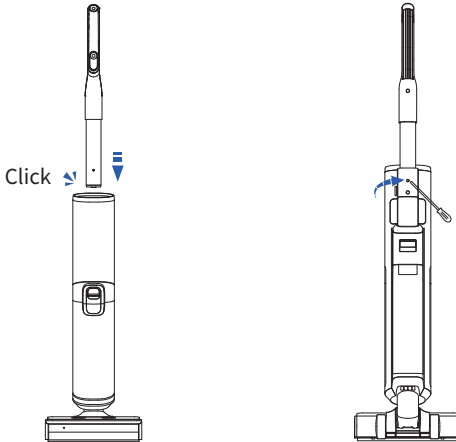

Charging

1. Connect the charger cable to the charging base first, then place the appliance on it. It may take 4 hours for a full charge.

(The battery can also be removed and separately charged on the base, but it must be ensured the charging slot is dry.)

2. To avoid tripping hazards, please place the appliance and the charging base close to a wall while charging.

Note: When not in use for a long period of time, the appliance must be charged once every month for optimal performance.

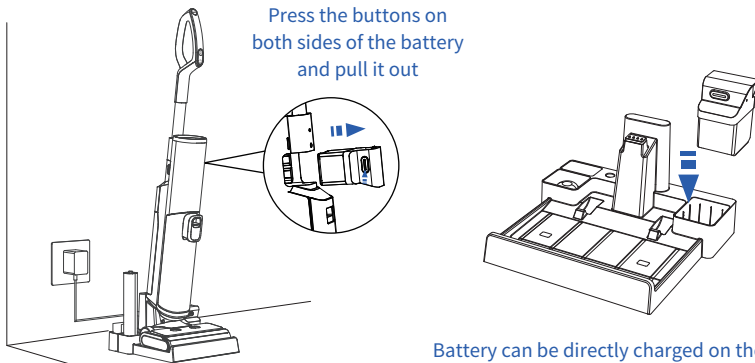

Battery can be directly charged on the base

Product Use

Operation

1. Press the power button and the appliance will start in SMART by default. Press it again to turn off.

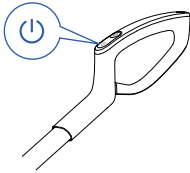

2. Press the function button to switch among SMART, MAX, Sterilization and Suction Modes.

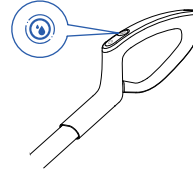

3. Long-press the power button for 5s to configure the network. For operation instructions, please follow the "APP Download and Connection Guide"

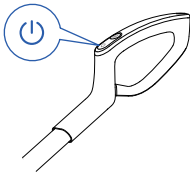

4. Press the Language/Mute button to switch languages (In sequence: English, German, French, Italian and Spanish). Long-press for 5s to turn on/off the voice.

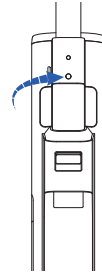

5. Do not recline the appliance more than 140° to prevent water leakage. (The appliance cannot be fully extended when the gap under the furniture is less than 50cm)

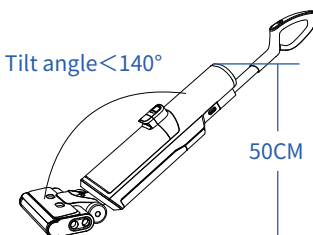

6. After use, place the appliance vertically on the charging base for charging and storage.

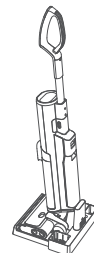

7. When the appliance is charged on the charging base, you can press the self-cleaning button to automatically clean the roller brush and tube. After the self-cleaning, the Sterilization UV Light and fan will be turned on automatically after a delay of 5s.

8. When the appliance is charged on the charging base, long-press the self-cleaning button for 5s to turn on/off the antibacterial lamp and fan.

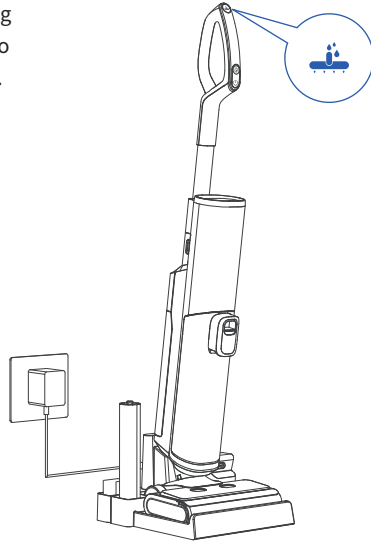

Cleaning Mode

SMART SMART Mode

In SMART mode, the appliance automatically applies different suction power and sprays the appropriate amount of water according to the degree of dirt on the floor detected by the sensor.

Sterilization Mode

In Sterilization mode, the appliance will make sterilizing solution and work in SMART mode.

MAX MAX Mode

In MAX mode, the appliance will apply max suction and spray max amount of water for deeper cleaning.

Suction Mode

In Suction mode, the appliance only absorbs liquids and does not spray water.

Product Maintenance

To get the best performance and prevent odors, thoroughly clean and dry the clean water tank, dirty water tank, filters, cleaning tool, roller brush and roller brush cover after each use.

After maintenance, place the appliance vertically on the charging base and store them in a dry place indoors.

Main Body

Before cleaning, stop the appliance and unplug the power plug. Clean the surface with water or neutral detergent and wring out the cloth to prevent water from entering the appliance.

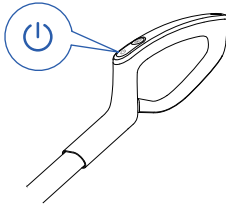

Dirty Water Tank

When the dirty water reaches the Max line, this appliance will stop work while displaying a reminder and playing a voice. Remove the tank, use a cleaning brush to remove residual debris, and flush the tank interior.

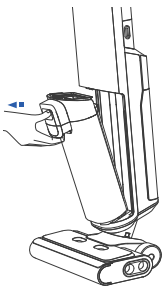

①

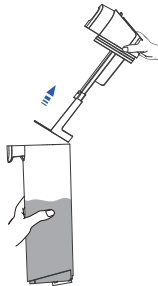

②

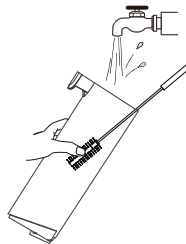

③

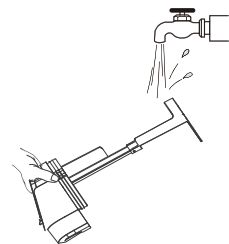

④

Roller brush self-cleaning

1. After use, put this appliance back to the charging dock for self-cleaning. Press the self-cleaning button to start the process.
2. After completion, you will hear the voice prompt “Cleaning completed, please clean the dirty water tank” .

Note: Before self-cleaning, the battery level should exceed 20%, the dirty water tank should be emptied, and the water level of the clean water tank should exceed 40%.

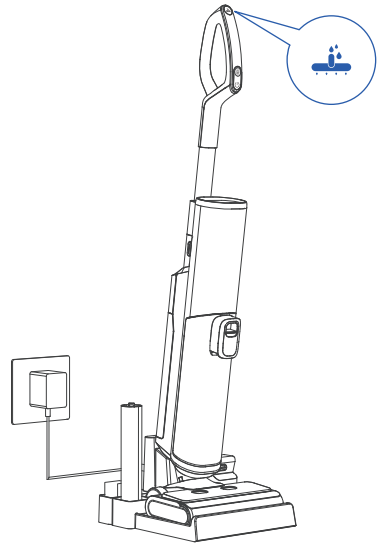

Filter

Grab the sides of the filter and pull it up. Wash it under running water, and then install it back into the machine until it is dry.

*** Your appliance has a spare filter for easy replacement.**

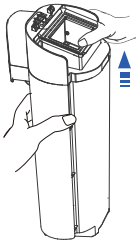

①

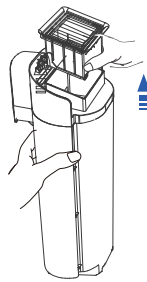

②

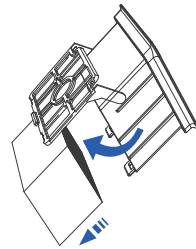

③

Product Maintenance

Roller brush top cover

1. Grab the front handle while holding down the button, and pull up to remove it.
2. Wash it with water.
3. Make sure the cover is locked in place when installed, to avoid water leakage.

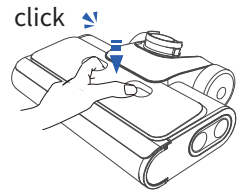
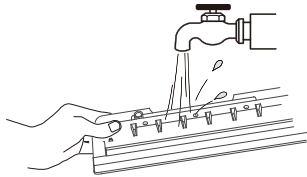
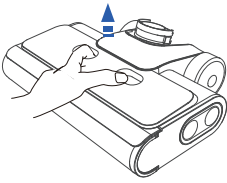

Roller Brush

1. Hold down the right button to remove the cover, and then pull out the Roller Brush to the right.
2. Remove hair and debris from the Roller Brush with a cleaning tool, and then rinse with water.
3. Remove hair and debris from the Roller Brush box and tube with the cleaning brush.

Note: Your appliance has a spare Roller Brush for easy replacement.

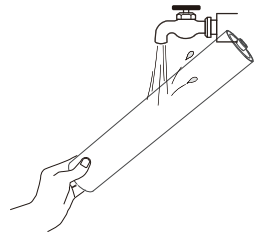
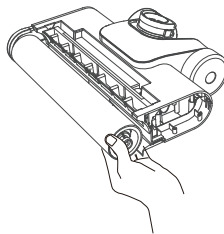
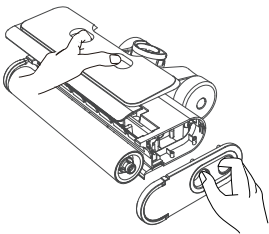

Troubleshooting

Problem	Possible cause	Solution
The appliance is not turned on	Automatic overheating protection	Restart after cooling down
Can not run after turning on Voice prompt: standby	The machine stands upright	Step on the roller brush top, press down the handle and enter the working state
All lights are off during operation	Battery overheat or malfunction	Restart after cooling down
Error indicator flashes Voice prompt: Check the roller brush	Roller brush is blocked; Roller brush not installed or absent	Clean the roller brush; Install the roller brush correctly
Error indicator flashes Voice prompt: Water shortage in clean water tank, please add water	Clean water tank is empty	Add water or liquid to the clean water tank and reinstall it
Error indicator flashes Voice prompt: Dirty water tank full, please clean up in time to avoid odor	Dirty water has reached the Max line	Empty the dirty water and reinstall the dirty water tank
Voice prompt: check the dirty water tank	Dirty water tank absent	Install the dirty water tank correctly
WiFi indicator OFF	WiFi disconnected	Follow the instructions in the APP to connect to WiFi
Battery level indicator flashes Voice prompt: insufficient power, please charge	Low battery	Charge the appliance or restart it
Weak suction	The filter is not installed; The filter is dirty of the tube is blocked.	Install the filter; Clean the filter and tube
High noise of the motor	The filter is not installed; The filter is dirty of the tube is blocked.	Install the filter; Clean the filter and tube
Error indicator flashes Voice prompt: Fan error	Motor fault	Shut down and restart after 2 minutes. If it still doesn't work, please contact the customer service: support@proscenic.com

Product Specification

Product model	WashVac F20
Charging input	100~240V
Voltage and electric quantity	21.6V, 4000mAh
Rated power	200W
Running time	SMART: ~40min MAX: ~25min
Charging time	4h
Water flow rate	45~200mL/min
Clean Water Tank Capacity	1L
Dirty Water Tank Capacity	0.9L
Water Resistant	IPX4

Proscenic Technology Co., Ltd. (Authorized manufacturer)

Shenzhen Proscenic Technology Co., Ltd. (manufacturer)
Floor 8, Block A, building 5, Tusincere Park, Longcheng street,
Longgang district, Shenzhen City, China

Proscenic Technology INC.
36 South 18th Avenue Suite A, Brighton CO 80601 United States

PROSCENIC EU LTD
71-75 Shelton Street, Covent Garden, London, WC2H 9JQ, ENGLAND



PROSCENIC TECHNOLOGY GmbH

Laubenhof 23, Essen Nordrhein-Westfalen 45326 Deutschland
E-mail:proscenicde@outlook.com Tel:+49211 9753 8868

Customer Service

Email: support@proscenic.com

Europe	North & South America
+ 44 (0)808 273 7688	+ 1(833) 313 1310
Mon-Fri. 9am-5pm (CET)	Mon-Fri. 9am-6pm (ET)



PROSCENIC

F20 英文说明书 欧英规

Design Date: 2022-01-07

物料编码	
成品尺寸	210*140mm / 16P
工 艺	封面封底过哑膜 / 骑马钉
材 质	封面/封底: 200G铜版纸 内页: 80G书纸
印刷要求	4C双面印刷
版 本	V1.11